

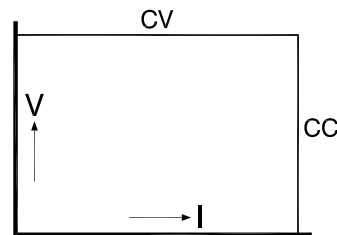

SM6000 - series
6000 watts DC POWER SUPPLIES

Three phase input

SM 15-400	0 - 15 V	0 - 400 A
SM 30-200	0 - 30 V	0 - 200 A
SM 45-140	0 - 45 V	0 - 140 A
SM 60-100	0 - 60 V	0 - 100 A
SM 70-90	0 - 70 V	0 - 90 A
SM 120-50	0 - 120 V	0 - 50 A
SM 300-20	0 - 300 V	0 - 20 A



- Efficiency up to 90 %
- Weight 27 kg
- 3 phase 380V, 400V, 415V AC input
480V optional
(48 - 62 Hz, line to line voltage)
- Active Power Factor Correction, PF=0.98
- 200 kHz MOSFET power conversion technique
- 0 - 5 V analog programmable
(on both voltage and current)
- Isolated analog programming with optional
ISO AMP CARD to prevent earth loops
- **Ethernet, IEEE 488** or **RS232** programming with
optional interface cards
- Very low HF-emission, OK for **light** industrial envi-
ronment, immunity OK for **industrial** environment

- Very low output ripple and spikes
- Very stable output voltage or current ($5 \cdot 10^{-5} - 10^{-4}$)
- Excellent dynamic response to load changes
- Master / Slave parallel and series operation with
equal current and voltage sharing
- Can be used as a building block to form a high
power unit
- Designed for long life at full power
- Protected against all overload and short circuit
conditions
- V and I control with 10-turn potentiometers,
resolution 0.03 %. Optional with digital encoders
- Silent blower, only runs when needed, variable
speed
- Output On/Off button, Interlock-connector

	SM 15-400	SM 30-200	SM 45-140	SM 60-100	SM70-90	SM 120-50	SM 300-20
Output voltage current	0 - 15 V 0 - 400 A	0 - 30 V 0 - 200 A	0 - 45 V 0 - 140 A	0 - 60 V 0 - 100 A	0 - 70 V 0 - 90 A	0 - 120 V 0 - 50 A	0 - 300 V 0 - 20 A
Input AC 3 phase, 48 - 62 Hz for use at 380V, 400V, 415V nominal line - line voltage	342 - 457 V	342 - 457 V	342 - 457 V	342 - 457 V	342 - 457 V	342 - 457 V	342 - 457 V
Option P165 for use at 440V, 480V (USA) (operates from 360V, but at derated output, 5300W@360V)	396 - 528 V	396 - 528 V	396 - 528 V	396 - 528 V	396 - 528 V	396 - 528 V	396 - 528 V
current (400V / 3 ph, full load) power factor, 100%, 50% load	10.2 A 0.98, 0.97	10 A 0.98, 0.97	10.3 A 0.98, 0.97	10 A 0.98, 0.97	10.4 A 0.98, 0.97	9.9 A 0.98, 0.97	10 A 0.98, 0.97
internal fuses standby input power (Vo=Io=0) standby input power (Vo=Vmax)	16 AT 55 W 110 W	16 AT 55 W 110 W	16 AT 55 W 110 W	16 AT 55 W 110 W	16 AT 55 W 130 W	16 AT 55 W 130 W	16 AT 55 W 120 W
Efficiency 400 VAC, 3 ph input, full load	87 %	89 %	90 %	89 %	89 %	89 %	89 %
Regulation							
Load 0 - 100% CV Line 342 - 457 V AC CV (external voltage sense)	2.5 mV 0.2 mV	5 mV 0.5 mV	5 mV 1 mV	5 mV 2 mV	5 mV 2 mV	8 mV 2 mV	15 mV 3 mV
Load 0 - 100% CC Line 342 - 457 V AC CC (internal voltage sense, after warm-up)	24 mA 4 mA	12 mA 2 mA	9 mA 1.5 mA	6 mA 1 mA	5 mA 1 mA	3 mA 0.5 mA	1.2 mA 0.2 mA
Ripple + noise rms (BW=300 kHz) CV p-p (BW=50 MHz) CV	0.8 mV 8 mV	1 mV 8 mV	1.5 mV 10 mV	2 mV 10 mV	2 mV 10 mV	3 mV 25 mV (20 mV @ full load)	5 mV 50 mV (30 mV @ full load)
rms (BW=300 kHz) CC p-p (BW=50 MHz) CC CC-ripple at full load	100 mA 300 mA	20 mA 60 mA	8 mA 25 mA	3 mA 10 mA	3 mA 10 mA	3 mA 10 mA	2 mA 5 mA
Temp. coeff., per °C CV CC				35.10 ⁻⁶ 60.10 ⁻⁶			
Stability after 1 hr warm-up during 8 hrs CV CC t _{amb} = 25 ± 1 °C, V _{in} = 400 VAC internal voltage sensing for CC-stab.				5.10 ⁻⁵ 10.10 ⁻⁵			

Analog Programming	CV	CC
Programming inputs input range accuracy offset temp. coeff. offset input impedance	0 - 5 V ± 0.2% - 0.1 ... +1.3 mV (on 5V) 10 µV / °C > 1 MOhm	0 - 5 V ± 0.5% 0 ... +2.2 mV (on 5V) 50 µV / °C > 1 MOhm
Monitoring outputs output range accuracy offset temp. coeff. offset output impedance	0 - 5 V ± 0.2% - 1... 0 mV (on 5V) 3 µV / °C 2 Ohm / max. 4 mA	0 - 5 V ± 0.5% - 1.1 ... 0 mV (on 5V) 60 µV / °C 2 Ohm / max. 4 mA
ISO AMP , option P154	Isolated 0 - 5 V / 200 kOhm or 0 - 10 V / 400 kOhm programming input range. See datasheet ISO AMP on www.DeltaPowerSupplies.com for accuracy, offset etc.	

Reference voltage on prog. connector	Vref TC	5.114 ± 15 mV (Ro = 2 Ohm, max. 4 mA) 20 ppm / °C
+12V output on prog. Connector	Vo I _{max} Ro	12 V ± 0.2 V 0.2 A 3 Ohm

Status outputs CC - status LIM - status OT - status PSOL - status ACF - status DCF - status	CC - operation CV or CC limit Over Temperature Power Sink Overload AC - Fail DC - Fail ¹⁾	5V = logic 1 (Ro = 500 Ohm) 5V = logic 1 (Ro = 500 Ohm) 5V = logic 1 (Ro = 500 Ohm) 5V = logic 1 (Ro = 500 Ohm) 5V = logic 1 (Ro = 500 Ohm) 5V = logic 1 (Ro = 500 Ohm)
Relay Outputs ACF DCF	AC - Fail DC - Fail ¹⁾	both NO and NC contact both NO and NC contact ¹⁾ output \pm 5% beyond set point
Remote shutdown	with + 5V, 1 mA or relay contact	
Interlock	contact at rear panel, see photo of rear panel on page 1-6	
Indicators (front panel)	AC-Fail, DC-Fail, Over Temperature, Power Sink Overload, Remote-Shutdown, Remote-CV, Remote-CC, Output On, CV-limit, CC-limit, CV- and CC- mode	
Controls (front panel)	Mains on/off, CV-and CC-potmeter, CV- and CC-limit-potmeter, Display-Settings button, Display-Limits button, Remote/Local, Output On/Off, Frontpanel Lock	

Programming speed <i>Standard Version</i> (resistive load)	SM 15-400	SM 30-200	SM 45-140	SM 60-100	SM 70-90	SM 120-50	SM 300-20
Rise time (10 - 90%) output voltage step time, (100 % load) time, (10 % load)	0 \rightarrow 15 V 3.3 ms 1.3 ms	0 \rightarrow 30 V 6.4 ms 2.5 ms	0 \rightarrow 45 V 2.7 ms 1.1 ms	0 \rightarrow 60 V 5.4 ms 2.2 ms	0 \rightarrow 70 V 6.8 ms 2.8 ms	0 \rightarrow 120 V 5.1 ms 1.9 ms	0 \rightarrow 300 V 8.5 ms 3.2 ms
Fall time (90 - 10%) output voltage step time, (100 % load) time, (10 % load)	15 \rightarrow 0 V 3.5 ms 34 ms	30 \rightarrow 0 V 6.7 ms 67 ms	45 \rightarrow 0 V 2.9 ms 32 ms	60 \rightarrow 0 V 5.8 ms 59 ms	70 \rightarrow 0 V 7.7 ms 77 ms	120 \rightarrow 0 V 4.9 ms 52 ms	300 \rightarrow 0 V 8.3 ms 83 ms
Programming speed <i>High Speed Version</i> (resistive load)	SM 15-400 <i>option P166</i>	SM 30-200 <i>option P167</i>	SM 45-140 <i>option P168</i>	SM 60-100 <i>option P169</i>	SM 70-90 <i>option P170</i>	SM 120-50 <i>option P171</i>	SM 300-20 <i>option P172</i>
Rise time (10 - 90%) output voltage step time, (100 % load) time, (10 % load)	0 \rightarrow 15 V 0.40 ms 0.38 ms	0 \rightarrow 30 V 0.41 ms 0.38 ms	0 \rightarrow 45 V 0.53 ms 0.16 ms	0 \rightarrow 60 V 0.44 ms 0.41 ms	0 \rightarrow 70 V 0.62 ms 0.40 ms	0 \rightarrow 120 V 0.57 ms 0.19 ms	0 \rightarrow 300 V 1.1 ms 0.44 ms
Fall time (90 - 10%) output voltage step time, (100 % load) time, (10 % load)	15 \rightarrow 0 V 0.39 ms 1.5 ms	30 \rightarrow 0 V 0.41 ms 3.6 ms	45 \rightarrow 0 V 0.26 ms 10 ms	60 \rightarrow 0 V 0.57 ms 5.6 ms	70 \rightarrow 0 V 0.50 ms 6.2 ms	120 \rightarrow 0 V 0.38 ms 4.2 ms	300 \rightarrow 0 V 1.0 ms 10 ms
Ripple @ full load typical (rms / pp)	6 / 20 mV	28 / 80 mV	34 / 80 mV	34 / 90 mV	38 / 100 mV	30 / 120 mV	48 / 150 mV
Output Capacitance (typical)	1200 μ F	800 μ F	520 μ F	330 μ F	290 μ F	73 μ F	32 μ F

	SM 15-400	SM 30-200	SM 45-140	SM 60-100	SM 70-90	SM 120-50	SM 300-20
Recovery time recovery within di/dt of load step output voltage time, @ 50 - 100% load step max. deviation	60 mV 5 A/ μ s 13 V 120 μ s 320 mV	50 mV 2.5 A/ μ s 25 V 100 μ s 260 mV	100 mV 1.8 A/ μ s 40 V 100 μ s 380 mV	100 mV 1.3 A/ μ s 55 V 100 μ s 250 mV	100 mV 1.7 A/ μ s 65 V 100 μ s 280 mV	0.5 V 1 A/ μ s 110 V 100 μ s 1 V	1 V 0.25 A/ μ s 280 V 100 μ s 1.8 V
Output impedance CV, 0-1 kHz CV, 1-100 kHz	< 0.5 m Ω < 2.3 m Ω	< 1.2 m Ω < 5 m Ω	< 1.7 m Ω < 10 m Ω	< 1.5 m Ω < 12 m Ω	< 1.8 m Ω < 12 m Ω	< 11 m Ω < 90 m Ω	< 34 m Ω < 330 m Ω
Pulsating load max. tolerable AC component of load current f > 1 kHz f < 1kHz	30 A rms 400 A peak	35 A rms 200 A peak	20 A rms 140 A peak	20 A rms 100 A peak	20 A rms 90 A peak	10 A rms 50 A peak	5 A rms 20 A peak

Insulation input / output creepage / clearance input / case output / case	3750 Vrms (1 min.) 8 mm 2500 Vrms 600 V DC
--	---

Safety	EN 60950 / EN 61010
EMC Power Supply Standard	EN 61204-3 , Emission: residential, light industrial environment (CISPR22-Class B) Immunity: industrial environment
Generic Emission Generic Immunity	EN61000-6-3 , residential, light industrial environment (EN55022 B) EN61000-6-2 , industrial environment
Operating Temperature at full load	- 20 to + 50 °C derate output to 75% at 60 °C
Humidity	max. 95% RH, non condensing, up to 40 °C max. 75% RH, non condensing, up to 50 °C
Storage temperature	- 40 to + 85 °C
Thermal protection	Output shuts down in case of insufficient cooling
MTBF	500 000 hrs

	SM 15-400	SM 30-200	SM 45-140	SM 60-100	SM 70-90	SM 120-50	SM 300-20
Hold-Up time V _{out} = 100% , I _{out} = 100% V _{out} = 85% , I _{out} = 100% V _{out} = 100% , I _{out} = 50% @ 400 VAC input	11 ms 23 ms 33 ms	11 ms 23 ms 28 ms	11 ms 23 ms 27 ms	11 ms 24 ms 28 ms	13 ms 23 ms 30 ms	13 ms 24 ms 32 ms	12 ms 24 ms 28 ms
Turn on delay after mains switch on	200 ms						
Inrush current	20 A (electronic limit)						
Phase loss	Output shuts down in case of phase loss						

Series operation max. total voltage Master / Slave operation	600 V yes						
Parallel operation Normal Master / Slave operation	no limit max. 3 units						
Remote sensing max. voltage drop per load lead	2 V						
Limits Voltage adjust range Current adjust range	0 - 102% 0 - 102%						
Potentiometers front panel control with knobs resolution screwdriver adjustment	standard 0.03 % (10 turns) option P001 (at front panel)						
Meters scale voltage scale current accuracy read output read limit setting (d = digit)	3.5 digit 0 - 15.00 V 0 - 400 A 0.5% + 2 d 2% + 2 d	3.5 digit 0 - 30.0V 0 - 200 A 0.5% + 2 d 2% + 2 d	3.5 digit 0 - 45.0V 0 - 140.0 A 0.5% + 2 d 2% + 2 d	3.5 digit 0 - 60.0V 0 - 100.0 A 0.5% + 2 d 2% + 2 d	3.5 digit 0 - 70.0 V 0 - 90.0 A 0.5% + 2 d 2% + 2 d	3.5 digit 0 - 120.0 V 0 - 50.0 A 0.5% + 2 d 2% + 2 d	3.5 digit 0 - 300 V 0 - 20.0 A 0.5% + 2 d 2% + 2 d

Mounting	Stacking of units allowed, air flow is from left to right.						
Input Terminals	Screw Terminals for cable 2.5 - 4 mm ² , 3 phase + earth (no neutral required)						
Output Terminals	M12 bolts	M10 bolts	M10 bolts	M10 bolts	M10 bolts	M8 bolts	M8 bolts
Programming connector	15 pole D-connector at rear panel (FEMALE)						
Cooling audio noise level airflow	Low noise blower, fan speed adapts to temperature of internal heatsink. ca. 56 dBA at full load, 25 °C ambient temperature, 1 m distance ca. 62 dBA at full load, 50 °C ambient temperature, 1 m distance from left to right						
Enclosure degree of protection	IP20						
Dimensions behind front panel: h x w x d front panel: h x w	177 x 443 x 500 mm 177 x 483 mm (19", 4 U)						
Weight	27 kg						

Digital Encoders

- CV and CC encoders with a very long life time and intelligent functions (e.g. Keylock).

OPTION P220**Screwdriver adjustment standard potentiometers**

- CV and CC knobs are moved backwards to avoid accidental adjusting.

OPTION P001**Master / slave operation**

- Parallel and Series operation with equal Current and Voltage sharing.
- This way two or more SM-units can be used together as one high power unit.
- Voltage and current of the units is controlled by the master (by potentiometers or by programming).
- Easy to connect in Master / Slave-mode, using standard UTP-cables (RJ45).
Standard on all SM6000 units, no special option required.

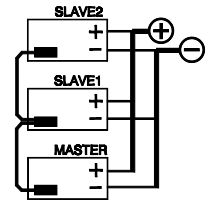
**Battery Charging**

- The CV / CC regulated power supplies are ideal battery chargers. Once set at the correct output voltage, the battery will charge constantly without overcharging. This can be useful for **emergency power systems**.
- Use a circuit-breaker in series to protect the internal diode from reverse connection of the battery.
- Some units need an **external diode set** on the output as extra protection for the internal diode.
- Ordering information for diode set:*

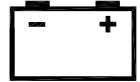

	SM45-140	SM120-50	SM300-20
option	P151	P152	P153

Download the special datasheet for more details from 'www.DeltaPowerSupplies.com'.

Increased max. output voltage/current**OPTION P069**

- The maximum output voltage or current can be increased by approximately 10%. Normally this results in a derating of the maximum ambient temperature or other parameters.
- Always add increased value for voltage or current in ordercode, for example **SM30-200 P069 output 32V**.
For exact details consult the technical department, email 'Support@Delta-Elektronika.nl'.

Enforced secondary isolation 1000 V**OPTION P089**

- The secondary isolation between output and ground is increased from standard 600 V to 1000 V .

High Speed Programming

- The speed is **10 - 20 times higher** because of the smaller output capacitors.
- Relatively low current overshoots (if any) in case of sudden voltage variations caused by the load, this is of great advantage for laser diode applications.

Applications:

- Laser diode** power supply, continuous or pulsed.
- Test systems requiring a fast settling time to improve throughput of factory.
- A constant current source with a low parallel capacitance: plasma, load sensitive to current overshoots, etc.
- A constant current source on a load with **fast voltage variations**.
- Ordering information:*

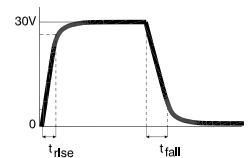

	SM15-400	SM30-200	SM45-140	SM60-100	SM70-90	SM120-50	SM300-20
option	P166	P167	P168	P169	P170	P171	P172

Download the special datasheet for more details from 'www.DeltaPowerSupplies.com'.

Power Sink for 2 quadrant operation

- Can absorb **700W peak power**.
- Maintains output voltage regardless output power is positive or negative (source & sink).
- Ideal solution for supplying **electric motors** with PWM-speed control.
- Fast down programming at no load conditions.
- Ordering information:*

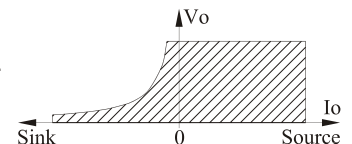

	SM15-400	SM30-200	SM45-140	SM60-100	SM70-90
option	P230	P231	P232	P233	P234

Download the special datasheet for more details from 'www.DeltaPowerSupplies.com'.

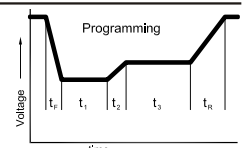
Built-in ISO AMP CARD for isolated analog programming**OPTION P154****Built-in RS232 Power Supply Controller****OPTION P155****Built-in IEEE488 Power Supply Controller****OPTION P156****Built-in Ethernet Power Supply Controller****OPTION P157****440 and 480 VAC input (USA)****OPTION P165**

Note: there is only room for one of the interfaces in a unit (P154, P155, P156, P157)

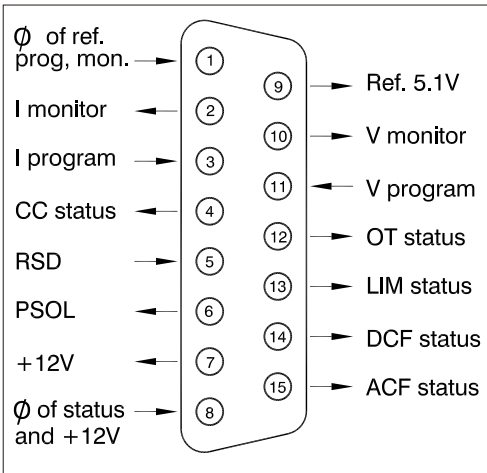

connections analog programming connector

CV= Constant Voltage
 CC= Constant Current

Specifications measured at
 $t_{amb} = 25 \pm 5^{\circ}C$ and $V_{in} = 400V AC, 50 Hz, 3 phase$, unless otherwise noted.

The information in this document is subject to change without notice

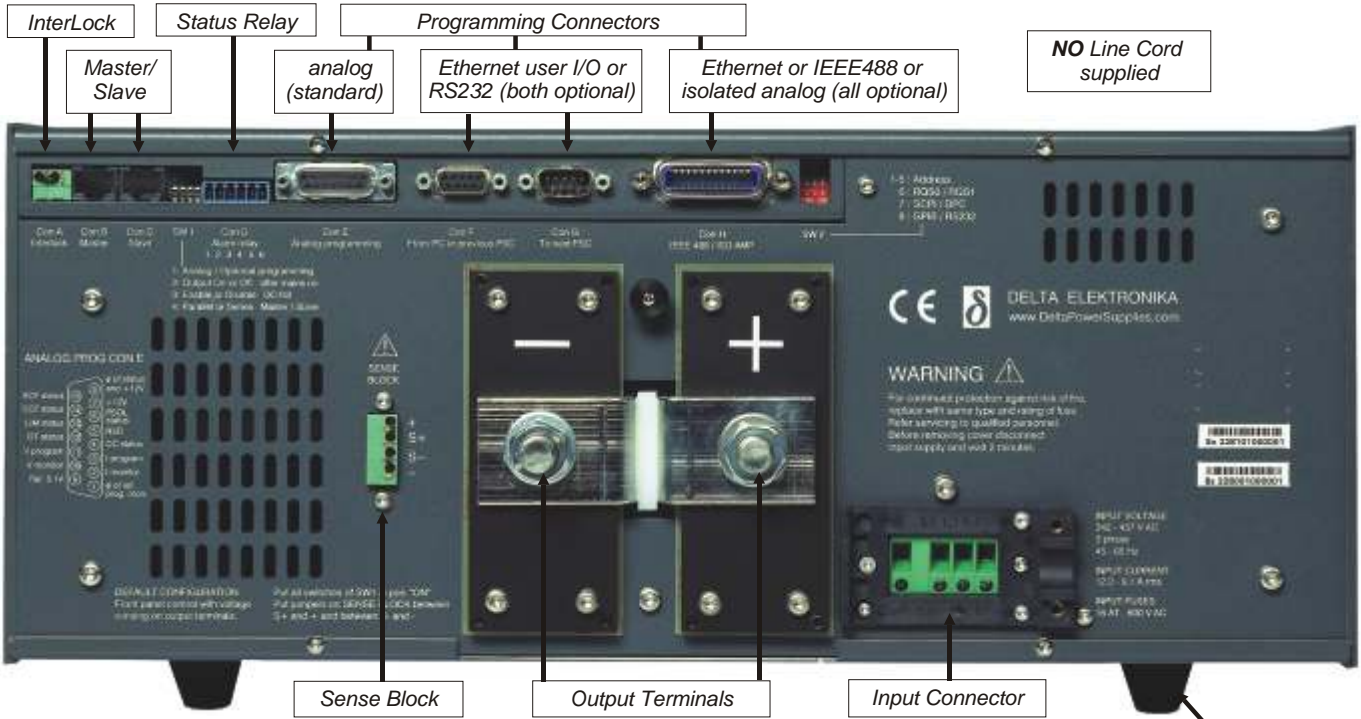
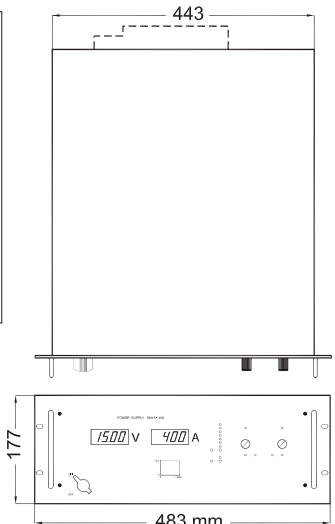
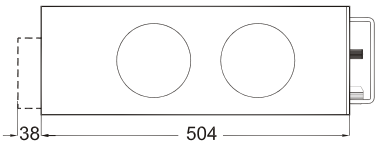

Sense Block, Output Terminals, Input Connector

Safety Covers supplied for in- and output (not shown)

Feet are not mounted but included in packing